

Ocean 11 Lab 7

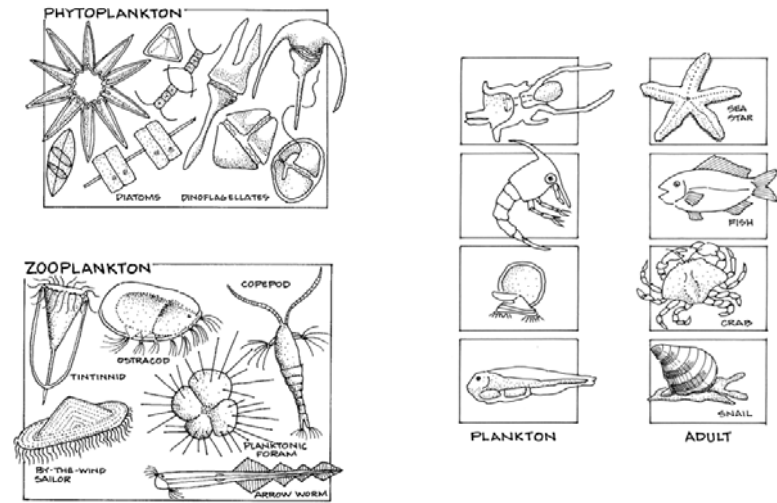

<http://octopus.gma.org/onlocation/globecactiv.html>

Phytoplankton <http://en.wikipedia.org/wiki/Phytoplankton>

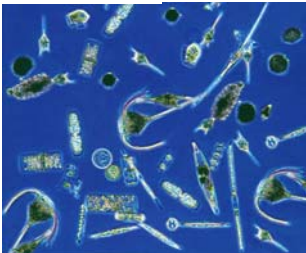

<http://www.seos-project.eu/modules/oceancurrents/oceancurrents-c04-p03.html>

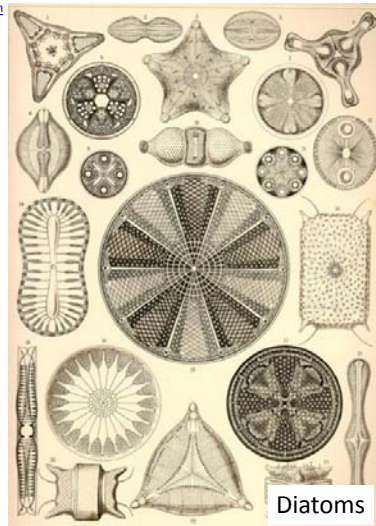
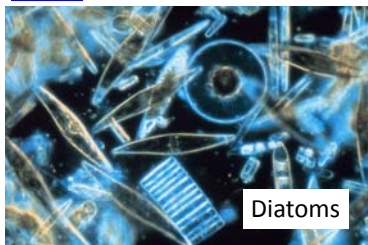

<http://www.digitalstar.net/microecologies/?p=57>

Diatoms

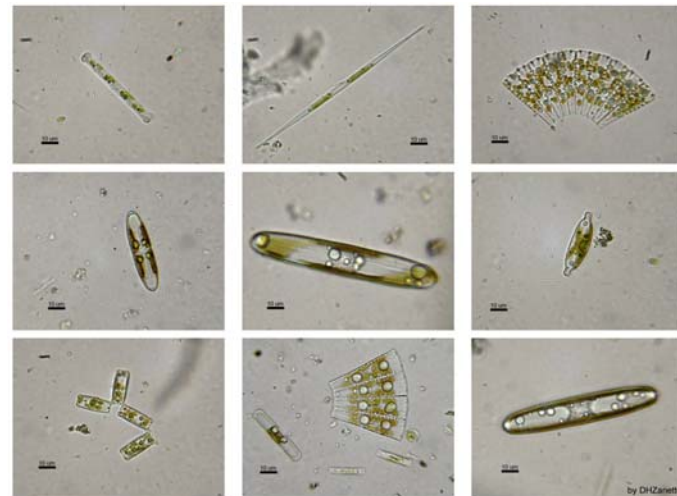

http://upload.wikimedia.org/wikipedia/commons/d/d2/Diatomeas_w.jpg

Zooplankton

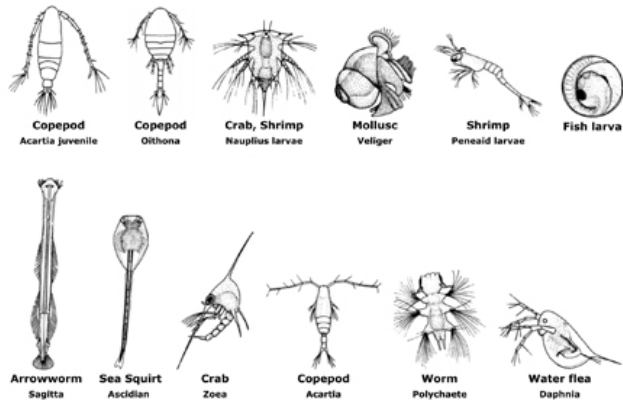

<http://floatingclassroom.tamu.edu/classmaterials/plankton.html>

Foraminifera



<http://www.microscopy-uk.org.uk/mag/indexmag.html>?
<http://www.microscopy-uk.org.uk/mag/artapr00/dwslide.html>

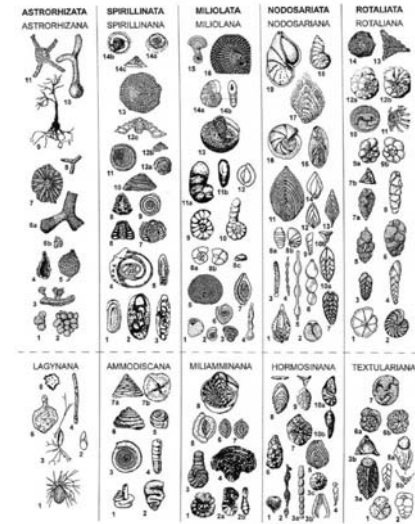

<http://www.foraminifera.eu/>

Zooplankton

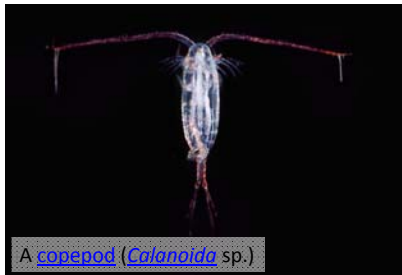

<http://en.wikipedia.org/wiki/Zooplankton>

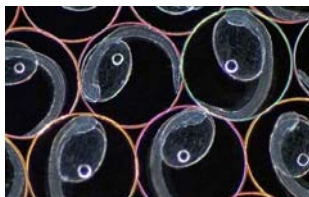

<http://www.telegraph.co.uk/earth/earthnews/2883836/Plankton-captured-in-stunning-close-up-photographs.html>

Coccolithophores

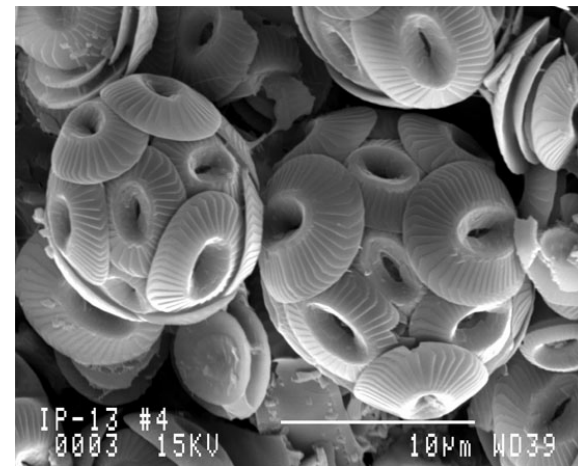

<http://www.whoi.edu/oceanus/viewImage.do?id=19972&aid=10366>

Radiolarians

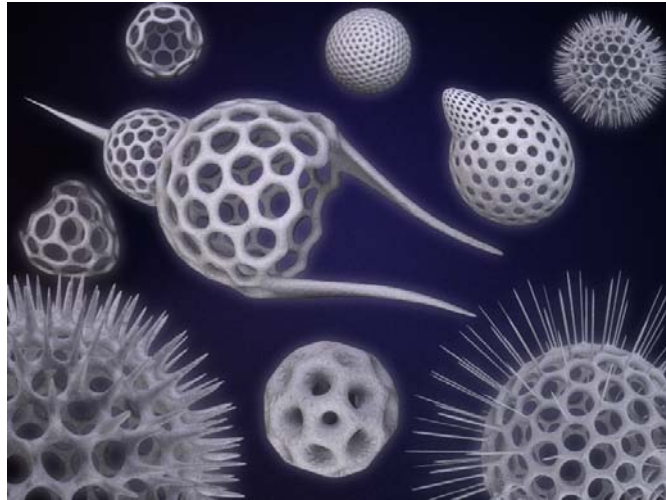

<http://shybeleiter.blogspot.com/>

Dinoflagellates



<http://incrediblebeings.wordpress.com/2010/08/16/where-does-red-tides-come-from/>

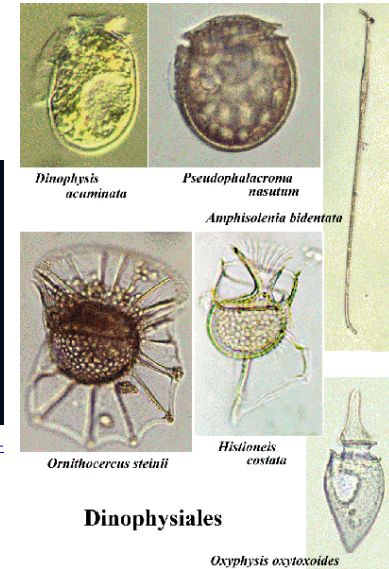

Dinophysiales

<http://en.wikipedia.org/wiki/Dinoflagellate>

<http://www.sci.hokudai.ac.jp/~horig/Dinohome/Eng-Documentation/Dinophyceae.html>

Dinoflagellates

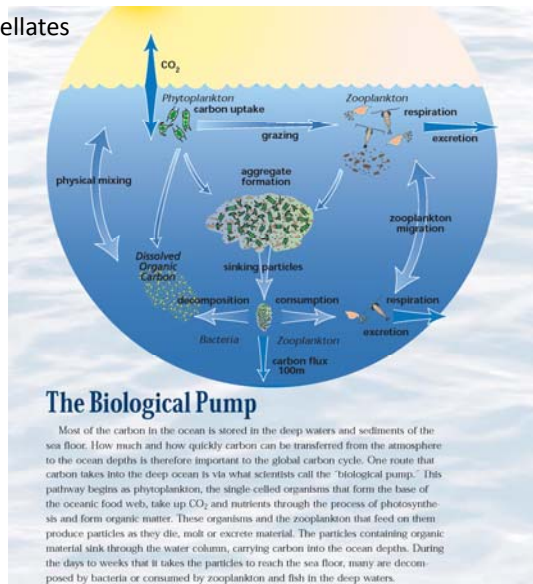

Dinoflagellates



Big River Plankton Sampling Transect

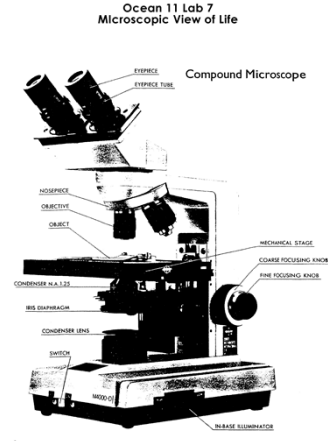
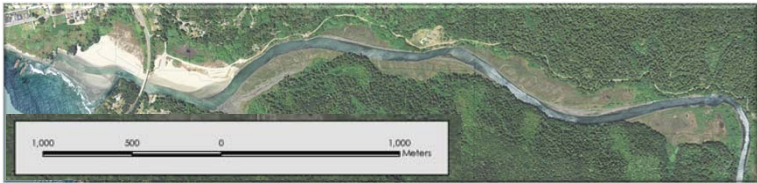

Introduction to Oceanography
Laboratory Exercise #7

Name _____

MARINE PLANKTON

Slide No. _____	Drawing:
Identification:	
Phytoplankton or Zooplankton?	
Holoplankton or Meroplankton?	
Slide No. _____	Drawing:
Identification:	
Phytoplankton or Zooplankton?	
Holoplankton or Meroplankton?	
Slide No. _____	Drawing:
Identification:	
Phytoplankton or Zooplankton?	
Holoplankton or Meroplankton?	

1

10